



Alu 067.0



GADOORALU
SISTEMAS DE ALUMÍNIO



PORTA DE ENTRADA
PUERTA DE ENTRADA





PORTA DE ENTRADA

— PUERTA DE ENTRADA —

05 | Porta de Entrada de Alumínio

- 08 . Gama Contemporânea [1]
- 16 . Gama Moderna [1]
- 20 . Gama Néó Vision [1]
- 22 . Gama Architect - Porta de Vidro [2]
- 28 . Gama Clássica [2]

30 | Porta de Serviço em Alumínio

- 30 . Porta de Serviço [3]

32 | Porta de Entrada de Aço

- 32 . Gama Contemporânea [4]

38 | Acessórios Para Porta de Entrada

- 38 . Puxador
- 39 . Alpendre
- 42 . Antecâmara

05 | Puerta de Entrada de Aluminio

- 08 . Gama Contemporânea [1]
- 16 . Gama Moderno [1]
- 20 . Gama Néó Vision [1]
- 22 . Gama Architect - Puerta de Cristal [2]
- 28 . Gama Clássica [2]

30 | Puerta de Serviço de Aluminio

- 04 . Puerta de Servicio [3]

32 | Puerta de Entrada de Acero

- 32 . Gama Contemporânea [4]

38 | Accesorios Para Puerta de Entrada

- 38 . Manilla
- 39 . Marquesina
- 42 . Esclusa



GADOORALU
SISTEMAS DE ALUMÍNIO

Parque Industrial de Laúndos,
Lote 37, 4570-311 Laúndos ,
Póvoa de Varzim - Portugal
+351 252 645 154
info@gadoor.net
www.gadoor.net

OPÇÕES . OPCIONES

- [1] Performance 50mm, Grandlux 65mm / 85mm, Prestige 105mm (pag.6-7)
- [2] ONDULINE . ARCHITECT / Consensus 30mm (pag.27)
- [3] Porta de serviço . Puerta de servicio (pag.31)
- [4] Constructor 50mm (pag.37)

GADOORALU





PORTA DE ENTRADA DE ALUMÍNIO

PUERTA DE ENTRADA DE ALUMINIO

AS VANTAGENS DOS PRODUTOS EM ALUMÍNIO

Estético

As portas de entrada são a solução ideal para moradias e edifícios possuindo flexibilidade das dimensões e a facilidade de montagem assegurando uma ótima qualidade final da instalação.

Durabilidade

O alumínio é extremamente resistente aos raios UV, as intempéries, à humidade, ao sol, às temperaturas extremas e à corrosão. Sendo o melhor parceiro para a sua casa.

Ambiente

O alumínio é totalmente reciclável, a sua reciclagem requer somente cerca de 5% da energia necessária para o produzir.

A sua utilização otimiza as perdas de energias do interior da sua habitação, e ainda combina o perfeito isolamento e impermeabilização, aumentando o conforto em sua casa.

Manutenção

Utilizar um pano húmido não abrasivo, sem utilização de produtos químicos.

LAS VENTAJAS DE LOS PRODUCTOS EN ALUMINIO

Estético

Las puertas de entrada son la solución ideal para casas y edificios poseyendo flexibilidad en las dimensiones y facilidad de montaje asegurando una optima cualidad al final de la instalación.

Durabilidad

El aluminio es extremamente resistente a los rayos UV, a la interperie , a la humedad, a sol, a las temperaturas extremas y a la corrosión. Siendo el mejor aliado para su casa.

Ambiente

El aluminio es totalmente reciclable, y este requiere solamente cerca del 5% de la energia necesaria para producirlo.

Su utilización optimiza las perdidas de calor del interior de su casa , y combina perfectamente el aislamiento y la impermeabilizacion, aumentando el confort en su casa.

Mantenimiento

Utilizar un paño húmido no abrasivo, sin utilización de productos químicos.



PERFORMANCE 50 MM

porta de alumínio . puerta de aluminio



AR / AIRE
vedação
sellado

ÁGUA / AGUA
permeabilidade
permeabilidad

VENTO / VIENTO
resistência
resistencia

Cor standard: Branco 9016, Cinzento 7016 (mate ou texturado)
Color standard: Blanco 9016, Gris 7016 (mate o texturado)

Pintura: QUALICOAT/QUALIMARINE /QUALANOD
Material: Painel de alumínio 50 mm com interior em XPS comprimido entre dois painéis de contraplacado PEFC
Vidro: 33^º fosco, 14 GAZ.4 FE.12 GAZ.5 fosco
Fechadura: 7 pontos de bloqueio
Cilindro de segurança: Europeu com 5 chaves e cartão de propriedade
Dobradiça: Regulável 80kg
Aro móvel: Em alumínio com corte-térmico
Sistema de abertura: Vedação Tripla
Sistema de retenção de água: Sim (anodizada)
Sistema PMR (Pessoa c/ Mobilidade Reduzida): Sim
Soleira: Anodizada c/ perfil de corte-térmico
Puxador: Inox
Outro: Possibilidade de integrar no perfil um sistema de isolamento e uma aba de cobertura interior
Suporte de fixação fornecido com parafusos
Ambiente: 100% Alumínio RECICLAVEL

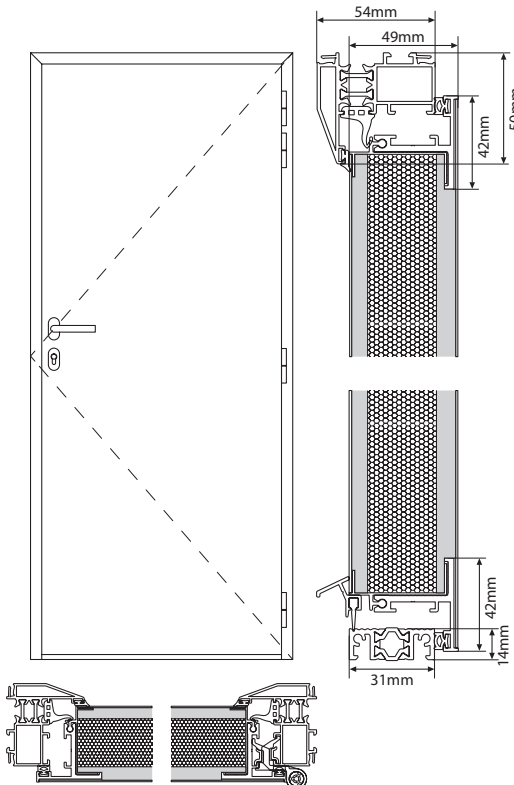

Pintura: QUALICOAT/QUALIMARINE /QUALANOD
Material: Panel de alumínio de 50 mm com interior de XPS comprimido entre dos paneles de contrachapado PEFC
Vidro: 33^º mate, 14 GAZ.4 FE.12 GAZ.5 mate
Cierre: 7 puntos de bloqueo
Cilindro de seguridad: Europeo con 5 llaves y tarjeta de propiedad
Bisagra: Ajustable 80kg
Marco móvil: En aluminio con rotura de puente térmico
Sistema de apertura: Triple sellado
Sistema de retención del agua: Si (anodizada)
Sistema PMR (Persona con Movilidad Reducida): Si
Umbral: Anodizada c/ perfil de rotura de puente térmico
Manilla: Inoxidable
Otro: Posibilidad de integrar en el perfil un sistema de aislamiento y una solapa de cubierta interior
El soporte de fijación se suministra con tornillos
Medio ambiente: 100% Aluminio RECICLABLE



Ud: 1,3 W/m².k
Desempenho acústico: 23 (-1, -2) dB (ISO 10140-2)
Cumple as normas da R.M.P.
(Pessoas com mobilidade reduzida)
EN 14351-1

Ud: 1,3 W/m².k
Rendimiento acústico: 23 (-1, -2) dB (ISO 10140-2)
Cumple con las regulaciones de la R.M.P.
(Personas con movilidad reducida)
EN 14351-1

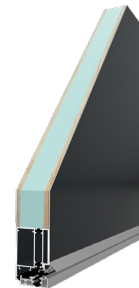

GRANDLUX 65 MM

porta de alumínio . puerta de aluminio

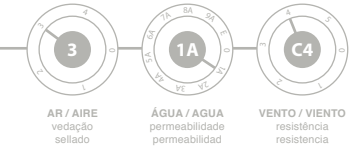

AR / AIRE
vedação
sellado

ÁGUA / AGUA
permeabilidade
permeabilidad

VENTO / VIENTO
resistência
resistencia

Cor standard: Branco 9016, Cinzento 7016 (mate ou texturado)
Color standard: Blanco 9016, Gris 7016 (mate o texturado)

Pintura: QUALICOAT/QUALIMARINE /QUALANOD
Material: Painel de alumínio 60 mm com interior em XPS comprimido entre dois painéis de contraplacado PEFC
Vidro: 33^º fosco, 20 GAZ.6 FE.20 GAZ.6 fosco
Fechadura: 7 pontos de bloqueio
Cilindro de segurança: Europeu com 5 chaves e cartão de propriedade
Dobradiça: Regulável 3D 120kg
Aro móvel: R-P.TH poliamida reforçada em fibra de vidro, perfil sem vedante
Aro fixo: 58 mm R-P.TH poliamida reforçada com fibra de vidro
Sistema de abertura: Vedação Tripla
Sistema de retenção de água: Sim (anodizada)
Sistema PMR (Pessoa c/ Mobilidade Reduzida): Sim
Soleira: Anodizada c/ perfil de corte-térmico
Puxador: Inox
Outro: Possibilidade de integrar no perfil um sistema de isolamento e uma aba de cobertura interior
Ambiente: 100% Alumínio RECICLAVEL

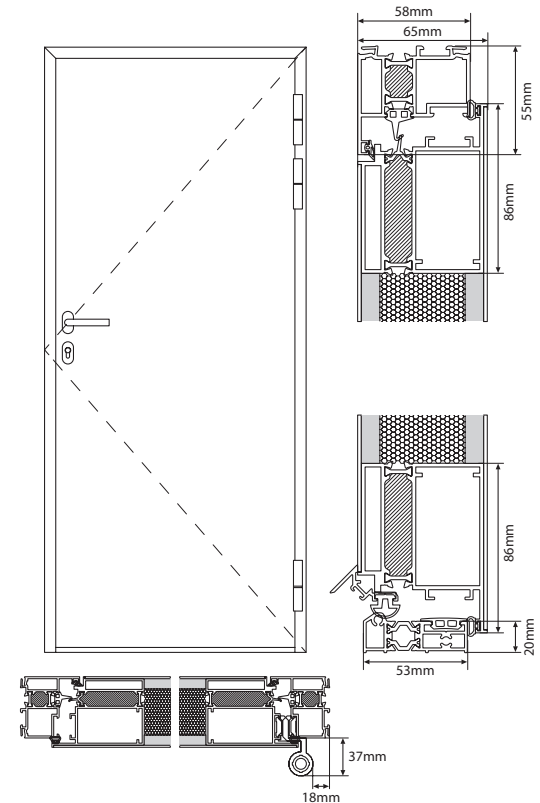

Pintura: QUALICOAT/QUALIMARINE /QUALANOD
Material: Panel de alumínio de 60 mm com interior de XPS comprimido entre dos paneles de contrachapado PEFC
Vidro: 33^º mate, 20 GAZ.6 FE.20 GAZ.6 mate
Cierre: 7 puntos de bloqueo
Cilindro de seguridad: Europeo con 5 llaves y tarjeta de propiedad
Bisagra: Ajustable 3D 120kg
Marco móvil: R-P.TH poliamida reforzada en fibra de vidrio, perfil no sellado
Marco fijo: 58 mm R-P.TH poliamida reforzada en fibra de vidrio
Sistema de apertura: Triple sellado
Sistema de retención del agua: Si (anodizada)
Sistema PMR (Persona con Movilidad Reducida): Si
Umbral: Anodizada c/ perfil de rotura de puente térmico
Manilla: Inoxidable
Otro: Posibilidad de integrar en el perfil un sistema de aislamiento y una solapa de cubierta interior
Medio ambiente: 100% Aluminio RECICLABLE



Ud: 1,4 W/m².k
Desempenho acústico: 31 (-1, -3) dB (ISO 10140-2)
Cumple as normas da R.M.P.
(Pessoas com mobilidade reduzida)
EN 14351-1

Ud: 1,4 W/m².k
Rendimiento acústico: 31 (-1, -3) dB (ISO 10140-2)
Cumple con las regulaciones de la R.M.P.
(Personas con movilidad reducida)
EN 14351-1



NEW 2021

GRANDLUX 85 MM

porta de alumínio . puerta de aluminio

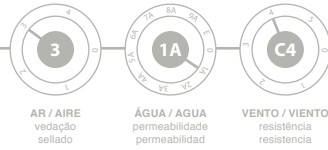

Cor standard: Branco 9016, Cinzento 7016 (mate ou texturado)
Color standard: Blanco 9016, Gris 7016 (mate o texturado)

Pintura: QUALICOAT/QUALIMARINE /QUALANOD
Material: Painel de alumínio 85 mm com interior em XPS comprimido entre dois painéis de contraplacado PEFC
Vidro: 4/4.2 fosco 32 GAZ 6 FE 25 GAZ 6 fosco
Fechadura: 7 pontos de bloqueio
Cilindro de segurança: Europeu com 5 chaves e cartão de propriedade
Dobradiça: Regulável 3D 120kg
Aro móvel: R-P.TH poliamida reforçada em fibra de vidro, perfil sem vedante
Aro fixo: 68 mm R-P.TH poliamida reforçada com fibra de vidro
Sistema de abertura: Vedação Tripla
Sistema de retenção de água: Sim (anodizada)
Sistema PMR (Pessoa c/ Mobilidade Reduzida): Sim
Soleira: Anodizada c/ perfil de corte-térmico
Puxador: Inox
Outro: Possibilidade de integrar no perfil um sistema de isolamento e uma aba de cobertura interior
Ambiente: 100% Alumínio RECICLAVEL

Pintura: QUALICOAT/QUALIMARINE /QUALANOD
Material: Panel de aluminio de 85 mm con interior de XPS comprimido entre dos paneles de contrachapado PEFC
Vidrio: 4/4.2 mate 32 GAZ 6 FE 25 GAZ 6 mate
Cierre: 7 puntos de bloqueo
Cilindro de seguridad: Europeo con 5 llaves y tarjeta de propiedad
Bisagra: Ajustable 3D 120kg
Marco móvil: R-P.TH poliamida reforçada em fibra de vidro, perfil no sellado
Marco fijo: 68 mm R-P.TH poliamida reforçada em fibra de vidro
Sistema de abertura: Triple sellado
Sistema de retenção del agua: Si (anodizada)
Sistema PMR (Persona con Movilidad Reducida): Si
Umbral: Anodizada c/ perfil de rotura de puente térmico
Manilla: Inoxidable
Otro: Posibilidad de integrar en el perfil un sistema de aislamiento y una solapa de cubierta interior
Medio ambiente: 100% Alumínio RECICLABLE

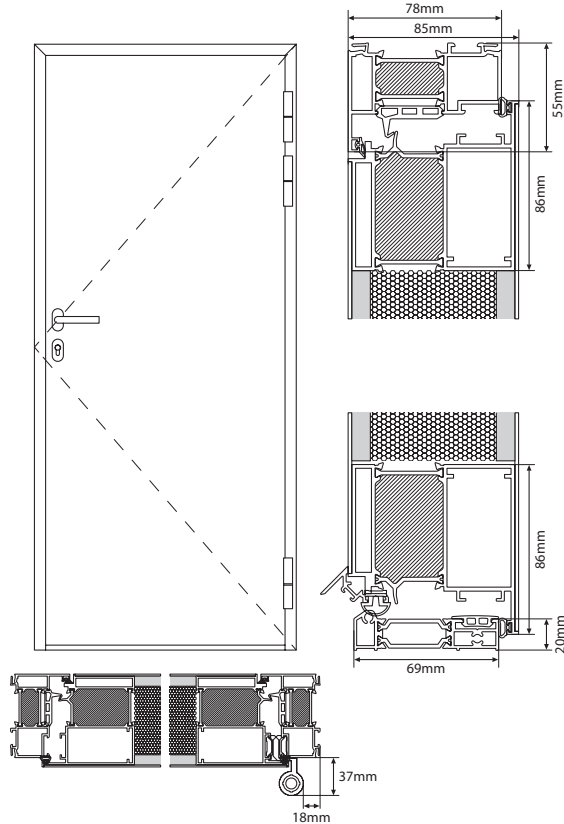

Ud: 0,91 W/m².k
Desempenho acústico: 32 (-1, -3) dB (ISO 10140-2)
Cumpre as normas da R.M.P.
(Pessoas com mobilidade reduzida)
EN 14351-1

Ud: 0.91 W/m².k
Rendimiento acústico: 32 (-1, -3) dB (ISO 10140-2)
Cumple con las regulaciones de la R.M.P.
(Personas con movilidad reducida)
EN 14351-1



NEW 2021

PRESTIGE 105 MM

porta de alumínio . puerta de aluminio

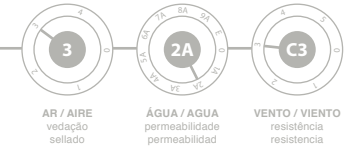

Cor standard: Branco 9016, Cinzento 7016 (mate ou texturado)
Color standard: Blanco 9016, Gris 7016 (mate o texturado)

Pintura: QUALICOAT/QUALIMARINE /QUALANOD
Material: Painel de alumínio 105 mm com interior em XPS comprimido entre dois painéis de contraplacado PEFC
Vidro: Vidros quádruplos CEKAL 44².26.4.26.4, com gás argón e espaçador térmico , 2x fosco
Fechadura: 7 pontos de bloqueio
Cilindro de segurança: Europeu com 5 chaves e cartão de propriedade
Dobradiça: Regulável 3D 120kg
Aro móvel: R-PT.H com revestimento de alumínio de 1,5 mm, com isolamento XPS ACERMI CSTB e contraplacado PEFC de 8 mm
Aro fixo: 95 mm R-P.TH poliamida reforçada com fibra de vidro
Sistema de abertura: Vedação Tripla
Sistema de retenção de água: Sim (alumínio anodizado)
Sistema PMR (Pessoa c/ Mobilidade Reduzida): Sim
Soleira: Com perfil de corte-térmico
Puxador: Inox
Ambiente: 100% Alumínio RECICLAVEL

Pintura: QUALICOAT/QUALIMARINE /QUALANOD
Material: Panel de aluminio de 105 mm con interior de XPS comprimido entre dos paneles de contrachapado PEFC
Vidrio: Vidrio quádruple CEKAL 44².26.4.26.4, con gas argón y espaciador térmico , 2x mate
Cierre: 7 puntos de bloqueo
Cilindro de seguridad: Europeo con 5 llaves y tarjeta de propiedad
Bisagra: Ajustable 3D 120kg
Marco móvil: R-PT.H con una cobertura de aluminio de 1,5 mm, con aislamiento XPS ACERMI CSTB y contrachapada PEFC de 8 mm
Marco fijo: 95 mm R-P.TH poliamida reforçada em fibra de vidro
Sistema de abertura: Triple sellado
Sistema de retenção del agua: Si (alumínio anodizado)
Sistema PMR (Persona con Movilidad Reducida): Si
Umbral: Con perfil de rotura de puente térmico
Manilla: Inoxidable
Medio ambiente: 100% Alumínio RECICLABLE

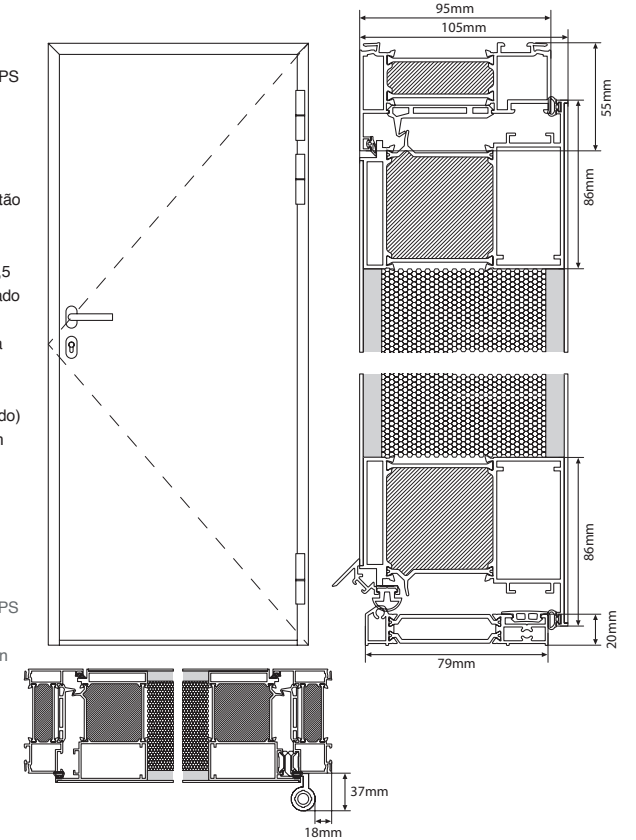

Ud: 0,7 W/m².k
Desempenho acústico: 28 (-1, -1) dB (ISO 10140-2)
Cumpre as normas da R.M.P.
(Pessoas com mobilidade reduzida)
EN 14351-1

Ud: 0.7 W/m².k
Rendimiento acústico: 28 (-1, -1) dB (ISO 10140-2)
Cumple con las regulaciones de la R.M.P.
(Personas con movilidad reducida)
EN 14351-1

PORTA DE
ENTRADA DE ALUMÍNIO
PUERTA DE ENTRADA DE ALUMINIO

■ Sicile



■ Gama Contemporânea

■ Gama Contemporânea

■ Sicile Alunox



■ Cabrera



■ Cabrera Alunox



Performance 50mm, Grandlux 65mm / 85mm, Prestige 105mm

■ Caprera Alunox



■ Asinara Alunox



■ Rhodes Alunox



■ Samos



■ Leucade Alunox



■ Kassos Alunox



■ Corfou



■ Corfou Alunox



■ Tilos Alunox



■ Tilos Alunox Plus



■ Vulcano Alunox



■ Vir Alunox



PORTA DE
ENTRADA DE ALUMÍNIO
PUERTA DE ENTRADA DE ALUMINIO

■ Paxos



■ Gama Contemporânea

■ Gama Contemporânea

■ Paxos Alunox



■ Molat



■ Molat Alunox



Performance 50mm, Grandlux 65mm / 85mm, Prestige 105mm

■ Gozo Alunox



■ Santorini



■ Capri



■ Andros



■ Montecristo



■ Capraia



■ Rinia



■ Rinia Alunox



■ Corse



■ Corse Alunox



■ Silba Alunox



■ Dia Alunox



PORTA DE
ENTRADA DE ALUMÍNIO
PUERTA DE ENTRADA DE ALUMINIO

■ Zante Alunox 1



■ Gama Contemporânea

■ Gama Contemporânea

■ Zante Alunox 2



■ Zante Alunox 3



■ Malte Alunox



Performance 50mm, Grandlux 65mm / 85mm, Prestige 105mm

Salina



Cunda



Cunda Alunox



Lundy



Lampedusa



Açores Alunox



Ibiza



Lipari Alunox



Pianosa Alunox



Saria Alunox



Kalamos Alunox

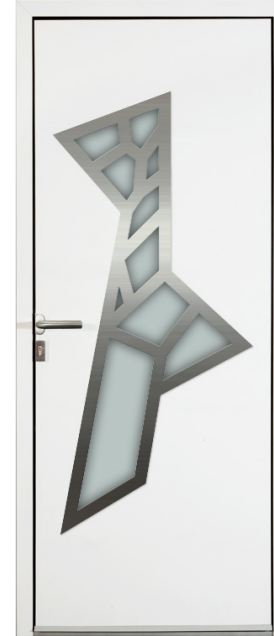

Madeira Alunox



**PORTA DE
ENTRADA DE ALUMÍNIO**
PUERTA DE ENTRADA DE ALUMINIO

Boa Vista



Gama Contemporânea

Gama Contemporânea

São Nicolau



Fogo



Brava





■ Maio



■ Santa Luzia



■ Santo Antão



■ São Vicente



■ Mindelo



Performance 50mm, Grandlux 65mm / 85mm, Prestige 105mm

PORTA DE
ENTRADA DE ALUMÍNIO
PUERTA DE ENTRADA DE ALUMINIO

■ Meyrin



■ Gama Moderna

■ Gama Moderno

■ Bulle

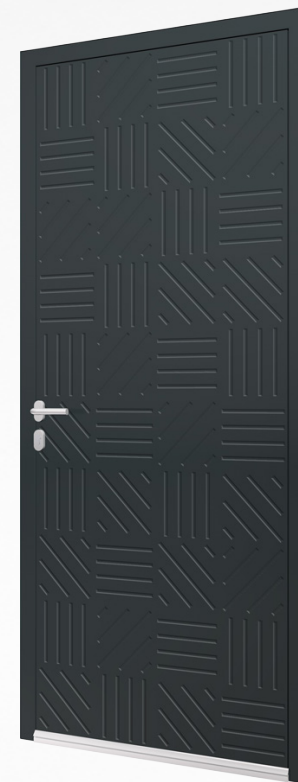

■ Baar





■ Lausanne



■ Salzburg



■ Essen



■ Francfort



■ Leipzig



Performance 50mm, Grandlux 65mm / 85mm, Prestige 105mm

PORTA DE
ENTRADA DE ALUMÍNIO
PUERTA DE ENTRADA DE ALUMINIO

■ Onex



■ Gama Moderna

■ Gama Moderno

■ Pully



■ Emmen

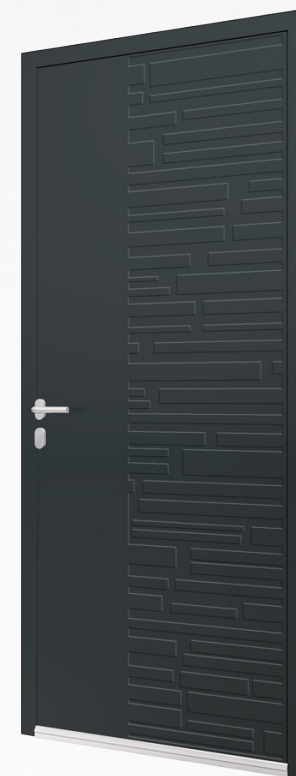



■ Lucerne



■ Geneve



■ Treves



■ Dortmund



■ Bale



Performance 50mm, Grandlux 65mm / 85mm, Prestige 105mm

**PORTA DE
ENTRADA DE ALUMÍNIO**
PUERTA DE ENTRADA DE ALUMINIO

■ Gama Néó Vision

■ Gama Néó Vision

■ Aleganza



■ Gran Canaria





■ Fuerteventura



■ Graciosa

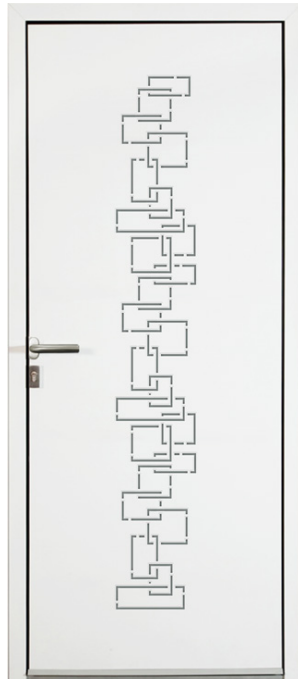

■ Tenerife



■ Palma



■ Gomera



Performance 50mm, Grandlux 65mm / 85mm, Prestige 105mm

PORTA DE
ENTRADA DE ALUMÍNIO
PUERTA DE ENTRADA DE ALUMINIO

■ Zante Norm.



■ Gama Porta de Vidro

■ Gama Puerta de Cristal

■ Zante Inv.



■ Corse Norm.



■ Corse Inv.



ARCHITECT / Consensus 30 mm

Vidro / Cristal: 4.12.44² FE, GAZ, WGE

■ Pianosa Norm.



■ Pianosa Inv.



■ Sicile Norm.



■ Sicile Inv.



■ Cunda Norm.



■ Cunda Inv.



■ Lipari Norm.



■ Lipari Inv.



■ Cabrera Norm.



■ Cabrera Inv.



■ Rinia Norm.



■ Rinia Inv.



**PORTA DE
ENTRADA DE ALUMÍNIO**
PUERTA DE ENTRADA DE ALUMINIO

■ Paxos Norm.



■ Gama Porta de Vidro

■ Gama Puerta de Cristal

■ Paxos Inv.



■ Molat Norm.



■ Molat Inv.



ARCHITECT / Consensus 30 mm

Vidro / Cristal: 4.12.44² FE, GAZ, WGE



■ Corfou Norm.



■ Corfou Inv.



■ Caprera



■ Asinara



■ Açores



■ Saria



■ Madeira



■ Leucade



■ Silba



■ Dia



■ Tilos



■ Vulcano



**PORTA DE
ENTRADA DE ALUMÍNIO**
PUERTA DE ENTRADA DE ALUMINIO

■ Tinos



■ Gama Porta de Vidro

■ Gama Puerta de Cristal

■ Syros



■ Milos



■ Malte



ARCHITECT / Consensus 30 mm

Vidro / Cristal: 4.12.44² FE, GAZ, WGE

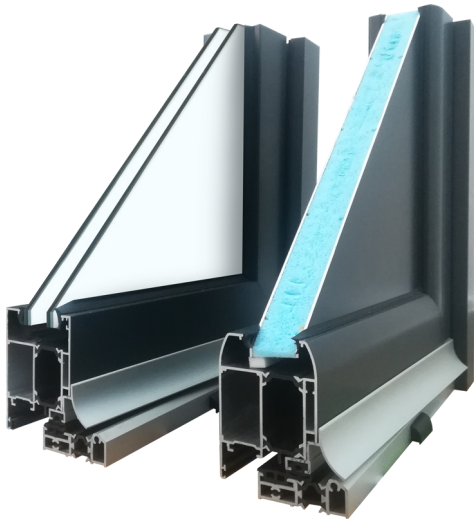

CONSENSUS 30 MM

porta de alumínio . puerta de aluminio

Cor standard: Branco 9016, Cinzento 7016 (mate ou texturado)
Color standard: Blanco 9016, Gris 7016 (mate o texturado)



Ud: 1,7 W/m².k
 Desempenho acústico: 26 (-2, -4) dB (ISO 10140-2)
 Cumpre as normas da R.M.P.
 (Pessoas com mobilidade reduzida)
 EN 14351-1

Ud: 1,7 W/m².k
 Rendimiento acústico: 26 (-2, -4) dB (ISO 10140-2)
 Cumple con las regulaciones de la R.M.P.
 (Personas con movilidad reducida)
 EN 14351-1



AR / AIRE
vedação
sellado

ÁGUA / AGUA
permeabilidade
permeabilidad

VENTO / VIENTO
resistência
resistencia

Pintura: QUALICOAT/QUALIMARINE /QUALANOD
Material: Painel de alumínio 30 mm com interior em XPS
Vidro: 4.18.44² FE, GAS, WGE
Fechadura: 7 pontos de fecho
Cilindro de segurança: Europeu com 3 chaves
Dobradiça: Regulável 80kg
Aro móvel: R-P.TH poliamida reforçada em fibra de vidro, perfil sem bits
Aro fixo: 63 mm R-P.TH poliamida reforçada com fibra de vidro, sistema integrado de revestimento externo ou de remate
Sistema de abertura: Vedação Tripla
Sistema de retenção de água: Sim (anodizada)
Sistema PMR (Pessoa c/ Mobilidade Reduzida): Sim
Soleira: Anodizada c/ perfil de corte-térmico
Puxador: Alumínio (Gama Clássica),
 Inox (Gama Porta de Vidro)
Ambiente: 100% Alumínio RECICLAVEL

Pintura: QUALICOAT/QUALIMARINE /QUALANOD
Material: Panel de alumínio de 30 mm con interior de XPS
Vidro: 4.18.44² FE, GAS, WGE
Cierre: 7 puntos de cierre
Cilindro de seguridad: Europeo con 3 llaves
Bisagra: Ajustable 80kg
Marco móvil: R-P.TH poliamida reforçada em fibra de vidro, perfil sin bits
Marco fijo: 63 mm R-P.TH poliamida reforçada em fibra de vidro, sistema de recubrimiento integrado externo o de remate
Sistema de apertura: Triple sellado
Sistema de retención del agua: Si (anodizada)
Sistema PMR (Persona con Movilidad Reducida): Si
Umbral: Anodizada c/ perfil de rotura de puente térmico
Manilla: Aluminio (Gama Clásica)
 Inoxidable (Gama Puerta de Cristal)
Medio ambiente: 100% Aluminio RECICLABLE

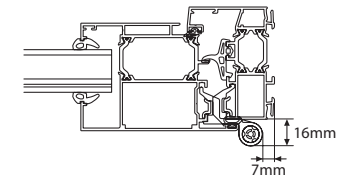
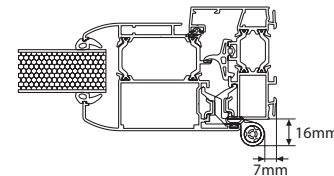
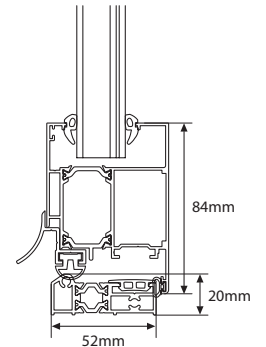
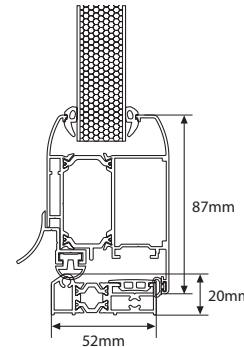
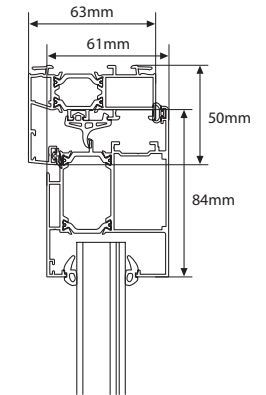
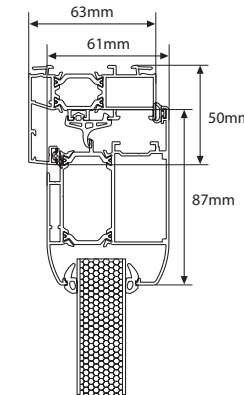

■ ONDULINE

■ ARCHITECT

PORTA DE
ENTRADA DE ALUMÍNIO
PUERTA DE ENTRADA DE ALUMINIO

■ Gama Clássica

■ Gama Clásica

■ Isabelle (opção vitral / opción de vidrio)



■ Isabelle



Opção vitral e painel
Opción de vidrio y panel

ONDULINE / Consensus 30 mm
Vidro / Cristal: 4.12.44² FE, GAZ, WGE



■ Isabelle



Opção painel
Opción panel

■ Louise



Opção vitral
Opción de vidrio

■ Louise



Opção painel
Opción panel

■ Laure



Opção vitral
Opción de vidrio

■ Laure



Opção painel
Opción panel

PORTA DE
SERVIÇO EM ALUMÍNIO
PUERTA DE SERVICIO DE ALUMINIO

■ PSP



■ PSO



PSP: Consensus 30 mm

PSO: Consensus 30 mm + vidro / vidrio 4.12.44² GAZ, WGE



PORTA DE SERVIÇO / PUERTA DE SERVICIO

porta de alumínio . puerta de aluminio

Cor standard: Branco 9016, Cinzento 7016 (mate ou texturado)

Color standard: Blanco 9016, Gris 7016 (mate o texturado)



AR / AIRE
vedação
sellado

ÁGUA / AGUA
permeabilidade
permeabilidad

VENTO / VIENTO
resistência
resistencia



Ud: 1,7 W/m².k
Desempenho acústico: 26 (-2, -4) dB (ISO 10140-2)
Cumple as normas da R.M.P.
(Pessoas com mobilidade reduzida)
EN 14351-1

Ud: 1,7 W/m².k
Rendimiento acústico: 26 (-2, -4) dB (ISO 10140-2)
Cumple con las regulaciones de la R.M.P.
(Personas con movilidad reducida)
EN 14351-1

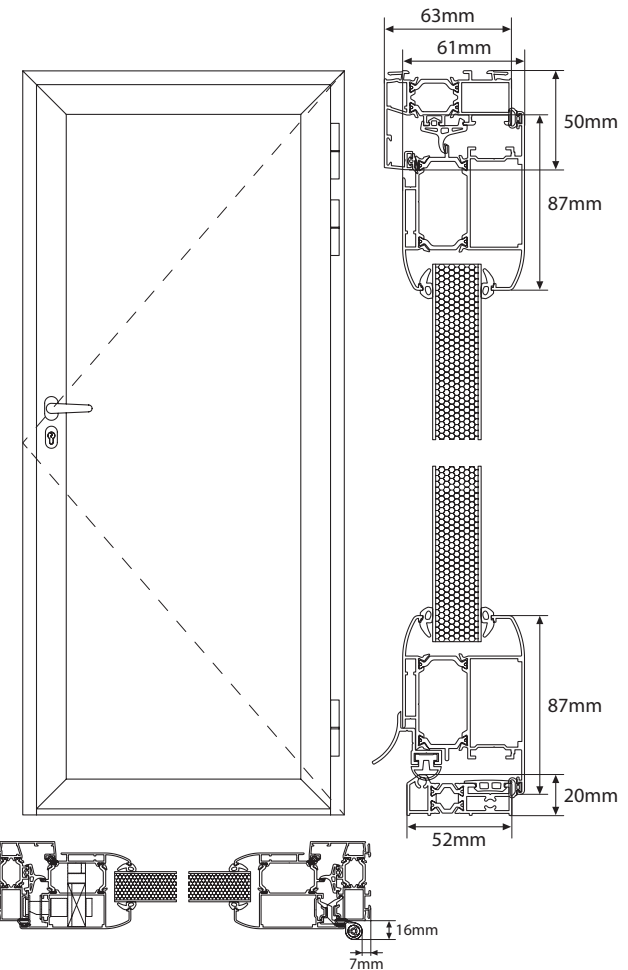

Pintura: QUALICOAT/QUALIMARINE /QUALANOD
Material: Painel de alumínio 30 mm com interior em XPS
Vidro: 4.12.44² FE, GAS, WGE
Fechadura: 7 pontos de fecho
Cilindro de segurança: Europeu + 3 chaves
Dobradiça: Regulável 80kg
Aro móvel: R-P.TH poliamida reforçada em fibra de vidro, perfil sem bits
Aro fixo: 63 mm R-P.TH poliamida reforçada com fibra de vidro, sistema integrado de revestimento externo ou de remate
Sistema de abertura: Vedação Tripla
Sistema de retenção de água: Sim (anodizada)
Sistema PMR (Pessoa c/ Mobilidade Reduzida): Sim
Soleira: Anodizada c/ perfil de corte-térmico
Puxador: Alumínio (Gama Clássica),
Inox (Gama Porta de Vidro)
Ambiente: 100% Alumínio RECICLAVEL

Pintura: QUALICOAT/QUALIMARINE /QUALANOD
Material: Panel de aluminio de 30 mm com interior de XPS
Vidrio: 4.12.44² FE, GAS, WGE
Cierre: 7 puntos de cierre
Cilindro de seguridad: Europeo + 3 llaves
Bisagra: Ajustable 80kg
Marco móvil: R-P.TH poliamida reforçada em fibra de vidro, perfil sin bits
Marco fijo: 63 mm R-P.TH poliamida reforçada em fibra de vidro, sistema de recubrimiento integrado externo o de remate
Sistema de abertura: Triple sellado
Sistema de retención del agua: Si (anodizada)
Sistema PMR (Persona con Movilidad Reducida): Si
Umbral: Anodizada c/ perfil de rotura de puente térmico
Manilla: Aluminio (Gama Clásica)
Inoxidable (Gama Puerta de Cristal)
Medio ambiente: 100% Alumínio RECICLABLE

PORTA DE
ENTRADA DE AÇO
PUERTA DE ENTRADA DE ACERO

■ Sicile Norm.



■ Gama Contemporânea

■ Gama Contemporânea

■ Sicile Inv.



■ Cabrera Norm.



■ Cabrera Inv.



Constructor 50 mm

■ Corfou Norm.



■ Corfou Inv.



■ Zante Norm.



■ Zante Inv.



■ Corse Norm.



■ Corse Inv.



■ Pianosa Norm.



■ Pianosa Inv.



■ Lipari Norm.



■ Lipari Inv.



■ Rinia Norm.



■ Rinia Inv.



PORTA DE
ENTRADA DE AÇO
PUERTA DE ENTRADA DE ACERO

■ Cunda Norm.



■ Gama Contemporânea

■ Gama Contemporânea

■ Cunda Inv.

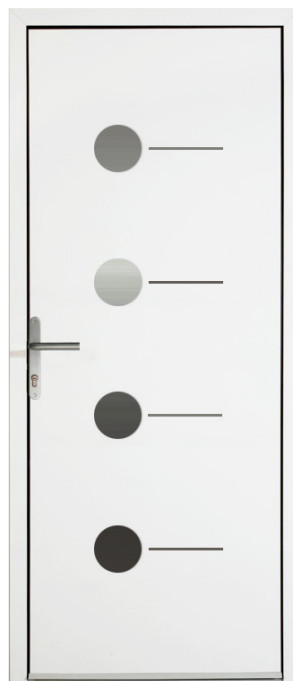

■ Molat Norm.



■ Molat Inv.



Constructor 50 mm

■ Paxos Norm.



■ Paxos Inv.



■ Leucade



■ Silba



■ Dia



■ Madeira



■ Asinara



■ Caprera



■ Equitation



■ Tilos



■ Vulcano



■ Açores



**PORTA DE
ENTRADA DE AÇO**
PUERTA DE ENTRADA DE ACERO

■ Gama Contemporânea

■ Gama Contemporânea

■ AB'6 Alunox



■ AB'6



■ Malte



■ Saria



■ Lisse



Constructor 50 mm



CONSTRUCTOR 50

porta de alumínio . puerta de aluminio

Cor standard: Branco 9016, Cinzento 7016 (mate ou texturado)

Color standard: Blanco 9016, Gris 7016 (mate o texturado)



Ud: 1,3 W/m².k
Desempenho acústico: 26 (-2, -4) dB (ISO 10140-2)
Cumple as normas da R.M.P.
(Pessoas com mobilidade reduzida)
EN 14351-1

Ud: 1.7 W/m².k
Rendimiento acústico: 26 (-2, -4) dB (ISO 10140-2)
Cumple con las regulaciones de la R.M.P.
(Personas con movilidad reducida)
EN 14351-1

Pintura: QUALICOAT/QUALIMARINE /QUALANOD

Material: Painel de aço ou alumínio 50 mm com interior em XPS comprimido entre dois painéis de contraplacado PEFC

Vidro: Duplo 33'.16.4

Fechadura: 7 pontos de bloqueio com elevação, cilindro de segurança europeu 40x30mm com 3 chaves

Dobradiça: 4 dobradiças ajustáveis tridimensionalmente

Sistema PMR (Pessoa c/ Mobilidade Reduzida): Sim

Soleira: Alumínio com perfil de corte-térmico 45x45 mm

Puxador: Inox

Ambiente: 100% Alumínio RECICLAVEL

Pintura: QUALICOAT/QUALIMARINE /QUALANOD

Material: Panel de acero o aluminio de 50 mm con interior de XPS comprimido entre dos paneles de contrachapado PEFC

Vidrio: Doble 33'.16.4

Cierre: 7 puntos de bloqueio com elevação, cilindro de seguridad europeo 40x30mm con 3 claves

Bisagra: 4 bisagras ajustables tridimensionalmente

Sistema PMR (Persona con Movilidad Reducida): Si

Umbral: Alumínio con perfil de rotura de puente térmico 45x45 mm

Manilla: Inoxidable

Medio ambiente: 100% Alumínio RECICLABLE

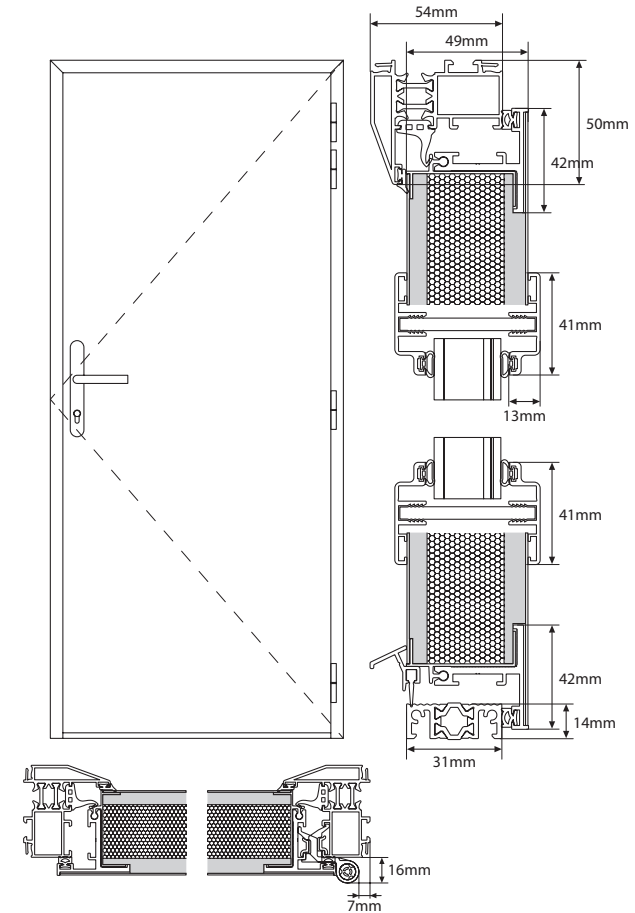

PUXADOR PARA PORTA DE ENTRADA

MANILLA DE LA PUERTA DE ENTRADA

STANDARD

Só possível com fechadura de 5 ou 7 pontos de elevação
Sólo es posible con cerradura de 5 o 7 puntos de elevación



■ P1 Onduline - Consensus 30



• Puxador em alumínio, ideal para Portas de Entrada em Alumínio da Gama Clássica e Portas de Serviço em Alumínio.

• Mango de aluminio, ideal para Puertas de Entrada de Aluminio de Gama Clásica y Puertas de Servicio de Aluminio.

■ P2 Performance 50, Grandlux 65 / 85, Prestige 105, Architect - Consensus 30



• Puxador em inox, ideal para Portas de Entrada em Alumínio da Gama Contemporânea, Moderna, Neo Vision e Portas de Vidro.

• Manilla de acero inoxidable, ideal para Puertas de Entrada de Aluminio de Gama Contemporánea, Moderna, Neo Visión y Puertas de Vidrio.

■ P3 Constructor 50



• Puxador em inox, ideal para Portas de Entrada em Aço da Gama Contemporânea.

• Manilla de acero inoxidable, ideal para Puertas de Entrada de Acero de Gama Contemporánea.

Opção para Porta de Entrada, só possível com fechadura de 3 pontos de gancho + 2 rolos

Opción para Puerta de Entrada, sólo es posible con cerradura de 3 puntos gancho + 2 rodillos



■ 07.432
• 300 mm



■ 07.002
• 300 mm



■ 07.123
• 300 / 600 / 900 mm



■ 07.143
• 400 mm



■ 07.005
• 600 / 1250 mm

ALPENDRE PARA PORTA DE ENTRADA

MARQUESINA DE LA PUERTA DE ENTRADA

■ CONSENSUS

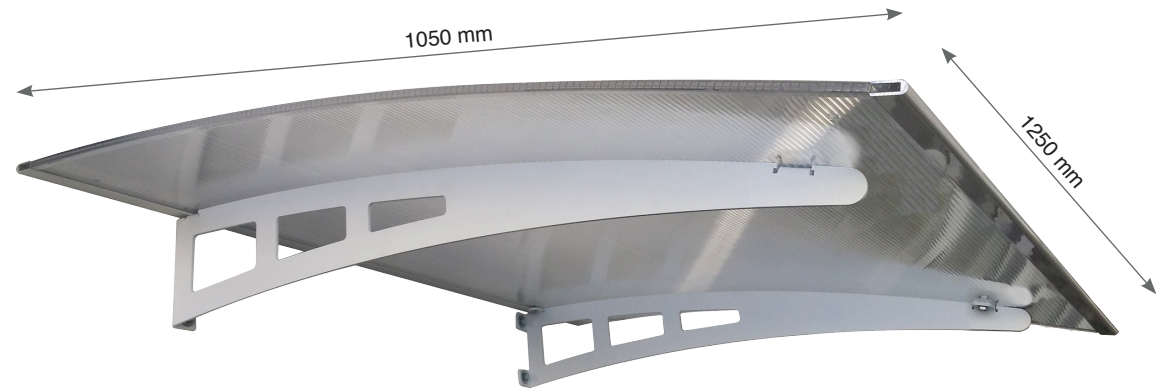

- Policarbonato alveolar de 6 mm com tratamento anti UV
- Perfis de acabamento frontal e traseiro em alumínio lacado
- Perfis laterais em policarbonato
- Braço em aço lacado com pintura epoxi
- Medidas Standard: 1250 x 1050 mm

- . Policarbonato alveolar de 6 mm con tratamiento anti UV
- . Perfiles de acabado de aluminio lacado en la parte delantera y trasera
- . Perfiles laterales en policarbonato
- . Brazo de acero lacado con pintura epoxi
- . Medidas Standard: 1250 x 1050 mm

ALPENDRE PARA PORTA DE ENTRADA

MARQUESINA DE LA PUERTA DE ENTRADA

GRANDLUX



- Medidas Standard: 1250 x 1050 mm, com um pilar ou opção personalizada com dois pilares
- Caleira 137 x 100 mm, pilar 100 x 100 mm com suporte de fixação ao chão e vidro texturado 33²
- QUALICOAT, QUALIMARINE, QUALANOD

- . Medidas Standard: 1250 x 1050 mm, con un pilar o la opción personalizada con dos pilares
- . Canalón 137 x 100 mm, pilar 100 x 100 mm con soporte de montaje en el suelo y vidrio con textura 33²
- . QUALICOAT, QUALIMARINE, QUALANOD



SKY DOOR



- Medidas Standard: 1250 x 1050 mm.
- Caleira 137 x 100 mm, tubo de suporte 30 x 30 mm e vidro texturado 33²
- QUALICOAT, QUALIMARINE, QUALANOD

- . Medidas Standard: 1250 x 1050 mm.
- . Canalón 137 x 100 mm, tubo de soporte 30 x 30 mm y vidrio con textura 33²
- . QUALICOAT, QUALIMARINE, QUALANOD

ART-PURE

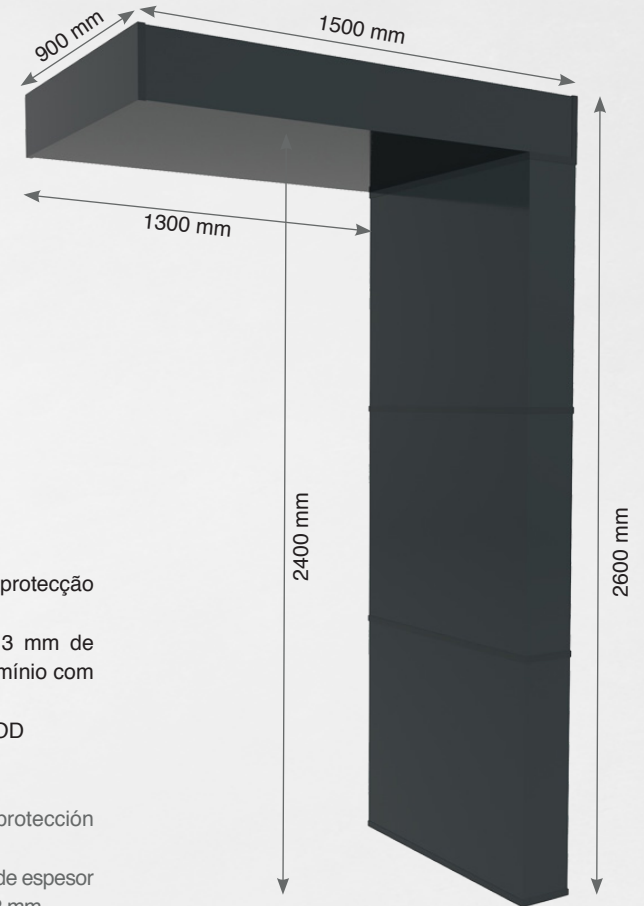

- Medidas Standard: 1500 x 2600 mm, com protecção superior e lateral
- Fabricado em placas de alucobon de 3 mm de espessura e fixadas em estruturas de alumínio com 8 x 22 mm
- QUALICOAT, QUALIMARINE, QUALANOD

- . Medidas Standard: 1500 x 2600 mm, con protección superior y lateral
- . fabricadas en placas de alucobón de 3 mm de espesor y fijadas en estructuras de aluminio de 8 x 22 mm
- . QUALICOAT, QUALIMARINE, QUALANOD

**ANTECÂMARA
DE PORTA DE ENTRADA**
ESCLUSA DE PUERTA DE ENTRADA



- Telhado em Policarbonato de 10 mm com tratamento anti-UV
- Janela de correr em alumínio sem ponto de ruptura térmica, com vidros 4.8.4
- Fechadura com chave
- Aro fixo de alumínio com vidro 4.8.4
- QUALICOAT/QUALIMARINE/QUALANOD

- Techo en Policarbonato de 10 mm con tratamiento anti-UV
- Ventana deslizante de aluminio sin rotura de puente térmico, con vidrio 4.8.4
- Cerradura con llave
- Fijo de aluminio con vidrio 4.8.4
- QUALICOAT/QUALIMARINE/QUALANOD

TELHADO MEIA ÁGUA
TECHO A MEDIA AGUA



TELHADO DUAS ÁGUAS
TECHO A DOS AGUAS



TELHADO CURVO
TECHO CURVO



Caleira
Canalón

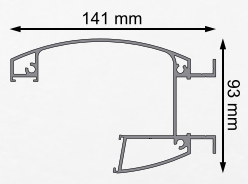

Pilar, Cumeeira
Poste, Cuneira

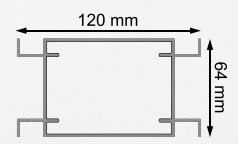

Pilar Exterior
Pilar Externo

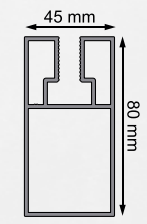

Pilar Intermédio
Pilar Intermedio

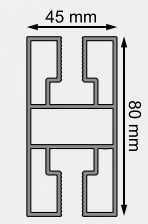

Sapata
Zapato

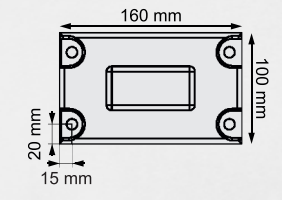



GADOORALU
SISTEMAS DE ALUMÍNIO

Parque Industrial de Laúndos, Lote 37, 4570-311 Laúndos , Póvoa de Varzim - Portugal
+351 252 645 154 info@gadoor.net